

# PULKRA

WWW.PULKRA.IT



ANTHOS  
BY DEBONADEMEO

MADE WITH ACRON®

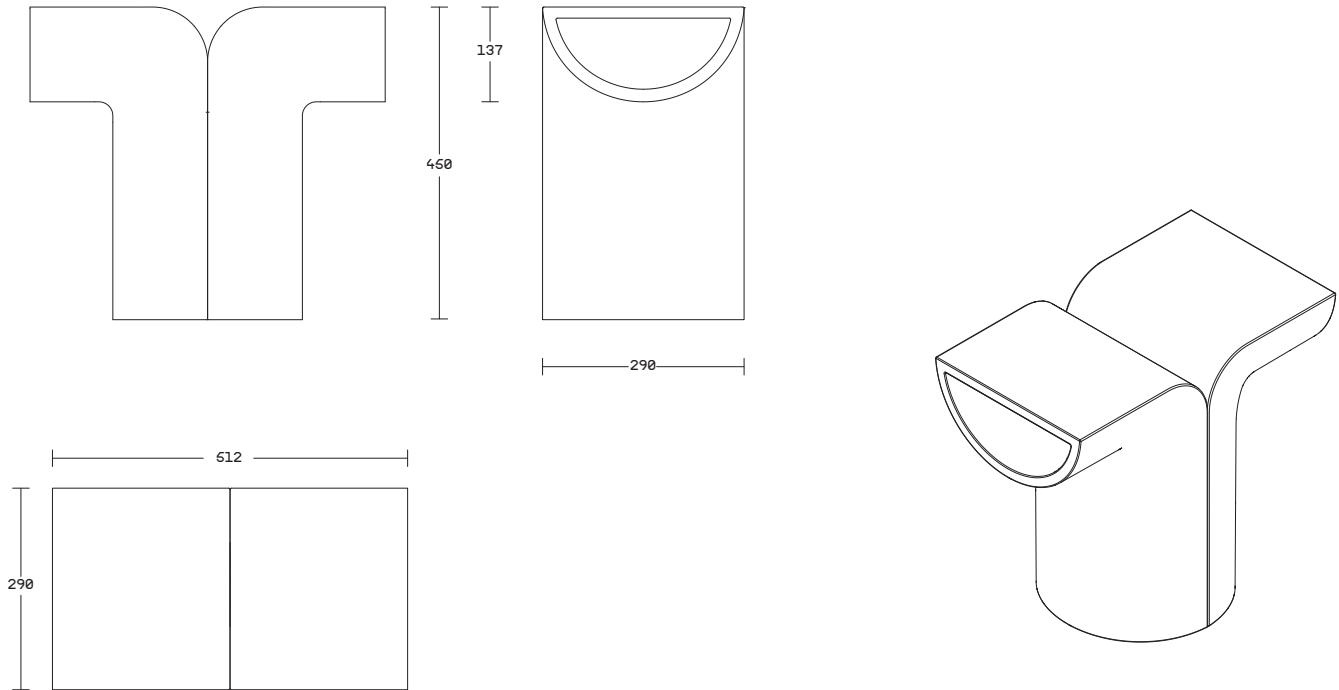

SKU

NTHS.CT 1.1

MISURE/SIZE

29 X 51,2 X H. 45

FINITURE/ FINISHES

BLACK , WHITE , ORIGIN , SOUL , RED , DESIRE , HOPE  
MEMORY , TIME , PURE , MIND , LIFE

PESO/WEIGHT

50 KG

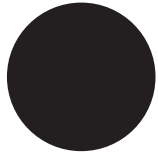

BLACK

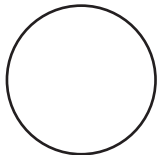

WHITE

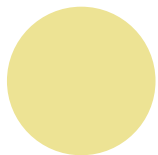

ORIGIN  
NCS S 0530-G80Y

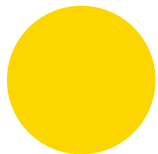

SOUL  
RAL 1018



RED  
NCS S 1085-Y80R

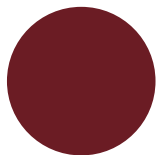

DESIRE  
RAL 3004

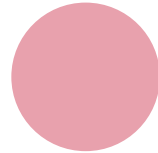

HOPE  
NCS S 0520-R10B

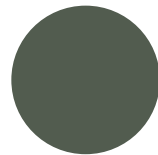

MEMORY  
RAL 7009

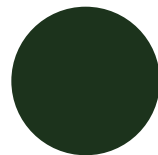

TIME  
RAL 6009

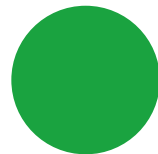

PURE  
RAL 6037

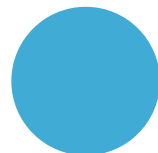

MIND  
NCS S 1050-B



LIFE  
RAL 5002

Un plinto di cemento si trasforma in un fiore ultraterreno che traduce la staticità della materia di cui è composto in un dinamismo compatto e vibrante. Il fusto centrale, che evoca vagamente le colonne binate dell'architettura classica, si sdoppia generando due top simmetrici che adempiono alla funzione di appoggio o di seduta. L'ispirazione naturalistica, che richiama all'architettura gotica e all'ingegneria infrastrutturale di Nervi, si affianca a un tecnicismo geometrico che sfrutta le caratteristiche del cemento per ottenere una sezione cava caratterizzata da minimi spessori. Il brutalismo si fa floreale, in un inedito accostamento di pieni e vuoti derivante da estrusioni formali che danno origine a piccole cavità dove poter riporre oggetti di uso comune. Evocando le atmosfere e le logiche di cantiere, Anthos è concepito come un modulo multifunzione, utilizzabile singolarmente oppure accostabile per formare un ampio coffee table o una seduta longitudinale capace di accogliere più persone.

*A concrete plinth transforms into an otherworldly flower that translates the static nature of the material it is composed of into a compact and vibrant dynamism. The central stem, vaguely reminiscent of the paired columns of classical architecture, splits into two symmetric tops that serve as supports or seating. The naturalistic inspiration, recalling Gothic architecture and the infrastructural engineering of Pier Luigi Nervi, is juxtaposed with geometric technicality that leverages the characteristics of concrete to achieve a hollow section characterized by minimal thicknesses. Brutalism becomes floral, in an unprecedented juxtaposition of solids and voids resulting from formal extrusions that give rise to small cavities where common objects can be stored. Evoking the atmospheres and logics of construction sites, Anthos is conceived as a multifunctional module, usable individually or combinable to form a large coffee table or a longitudinal seat capable of accommodating multiple people.*

# PULKRA

[WWW.PULKRA.IT](http://WWW.PULKRA.IT)



MONTAGGIO/ASSEMBLY

Si consiglia di far eseguire l'installazione a personale qualificato. Per la movimentazione degli elementi Anthos saranno necessarie 2 persone. Attenzione, durante la movimentazione del prodotto, onde evitare di danneggiare il cemento, si consiglia di appoggiare sempre i diversi elementi su una superficie protettiva.

*Installation should only be carried out by qualified tradespeople. 2 people will be needed to move the Anthos elements. Take care when handling this product to avoid damaging the concrete. We recommend placing it on a protective surface such as cardboard or a sheet.*

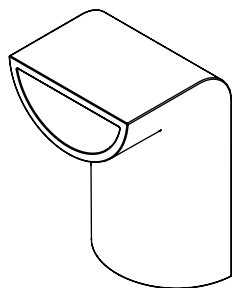

X2 ANTHOS NTHS.CT 1.1

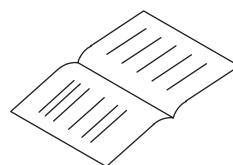

X1 MANUAL AND SCREWS

---

1

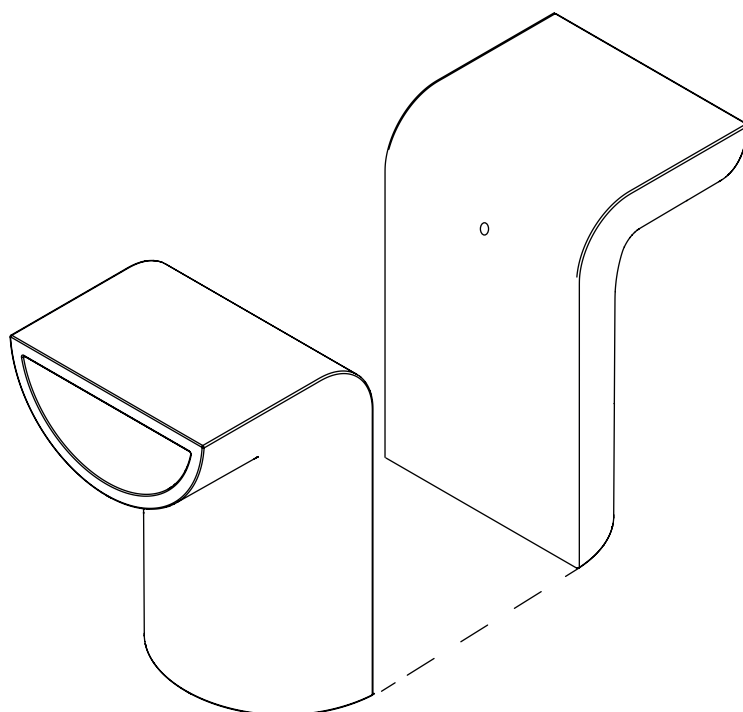

---

IT • ALLINEARE I DUE ANTHOS E AFFIANCARE LE DUE SUPERFICI PIATTE.

EN • ALIGN THE TWO ANTHOS AND PLACE THE TWO FLAT SURFACES SIDE BY SIDE.

---

---

2

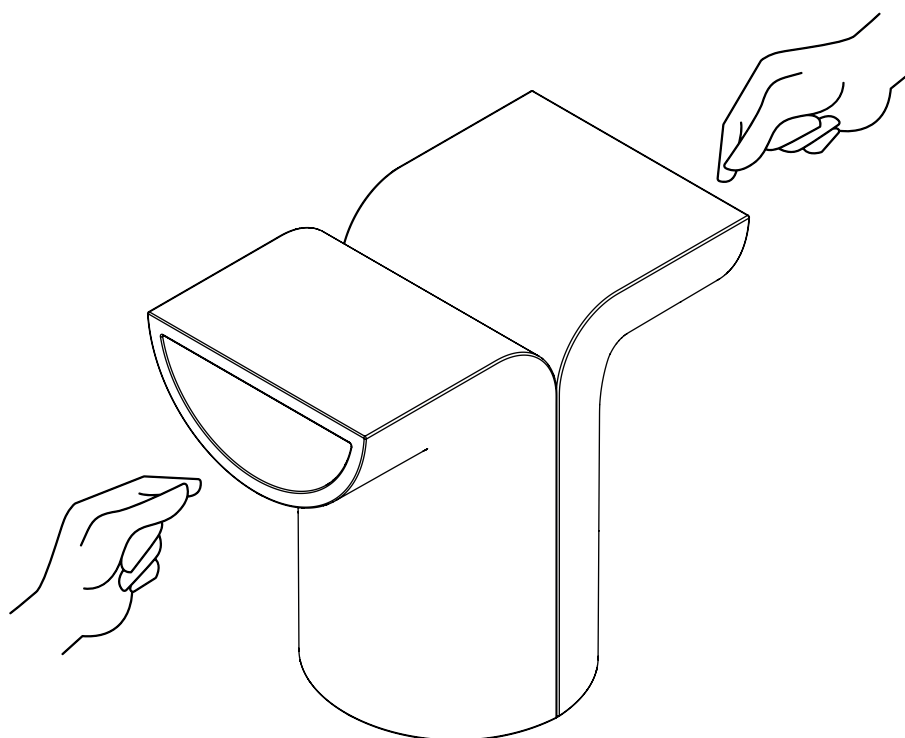

---

IT • FACENDOSI AIUTARE DA UNA PERSONA, INFILARE LE MANI NEI DUE FORI E STRINGERE IL BULLONE DI FISSAGGIO.

EN • WITH THE HELP OF A PERSON, INSERT YOUR HANDS INTO THE TWO HOLES AND TIGHTEN THE FIXING BOLT.

---



---

Se dovessi avere problemi nell'assemblare il tuo prodotto, contattaci all'indirizzo [info@pulkra.it](mailto:info@pulkra.it). Siamo sempre felici di aiutarti!

Abbiamo selezionato attentamente i materiali utilizzati in questo prodotto e ti chiediamo di trattarlo con responsabilità. Ti preghiamo di riciclare tutto l'imballaggio secondo le norme locali di smaltimento.

*Should you have any problems assembling your product contact us at [info@pulkra.it](mailto:info@pulkra.it). We're always happy to help! We have carefully selected the materials used in this product, and ask you to treat it responsibly too. Please recycle all packaging according to your local disposal rules.*